

# Quick Installation Guide

## SG250HX

### PV Grid-connected Inverter

SG250HX-QIEN-Ver11-201911 Version: 1.1



This guide is valid for inverters SG250HX, providing the installation, electrical connection, commissioning and troubleshooting procedure.

**⚠ NOTICE**

- Contents may be periodically updated or revised due to product development, The information in this guide is subject to change without notice. In no case shall this guide substitute for the user manual or related notes on the device.
- Make sure to read over, fully understand and strictly follow the detailed instructions of the user manual and other related regulations before installing the equipment. The user manual can be downloaded by visiting the website at <http://support.sungrowpower.com/>; or it can be obtained by scanning the QR code on the side of the equipment or the back cover of this guide.
- All operations can be performed only by qualified personnel, that must be trained in the installation and commissioning of the electrical system, as well as the dealing with hazards, have knowledge of the manual and of the local regulations and directives.
- Before installation, check that the package contents are intact and complete against the packing list, Contact SUNGROW or the distributor in case of any damaged or missing components.
- The cable must be intact and well insulated, Operation personnel must wear proper personal protective equipment (PPE) all the time.

# 1 Product Introduction

## 1-1 Appearance

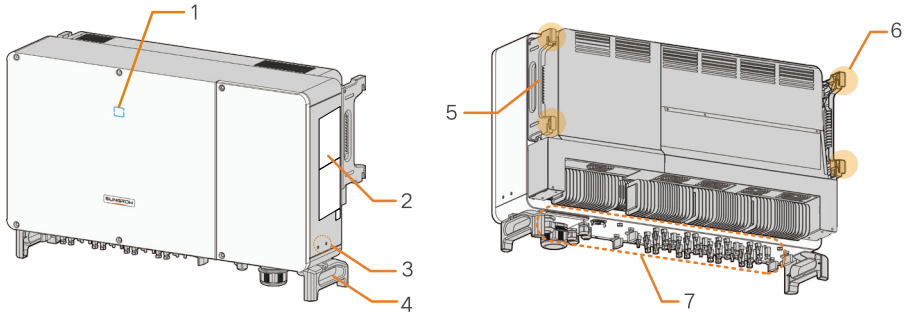

1. LED indicator    2. Warning symbols, nameplate, and QR code    3. Additional grounding terminals    4. Bottom handles  
 5. Side handles    6. Mounting ear    7. Wiring area

## 1-2 Dimensions

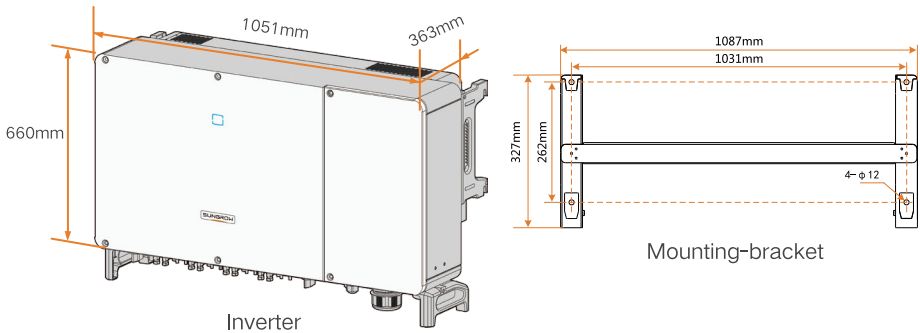

\*The image shown here is for reference only. The actual product you receive may differ.

## 2 Mechanical Mounting

### 2-1 Location Selection

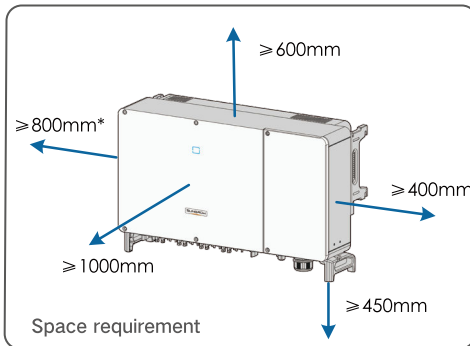
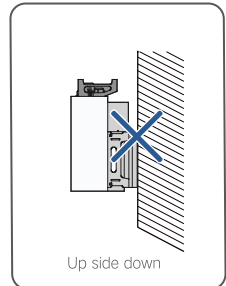
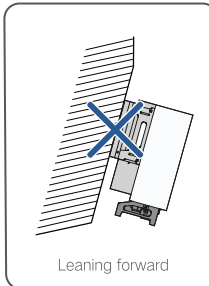
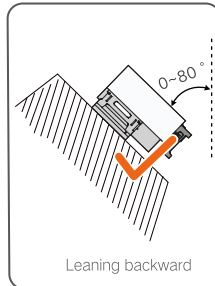
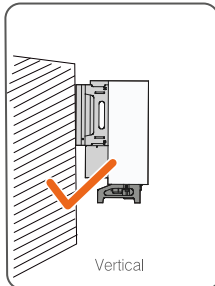
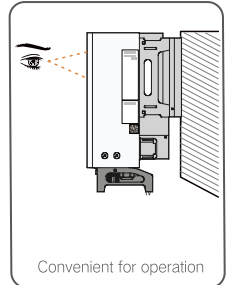
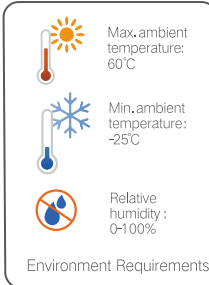
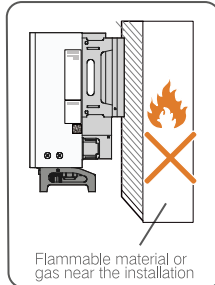
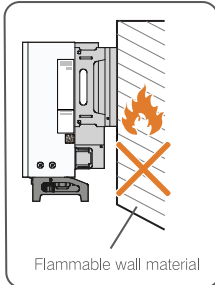

\* The distance can be shortened to 200mm according to onsite conditions. In case the distance is less than 800mm, move the inverter from the mounting-bracket or wall before maintaining fans.

### 2-2 Installation

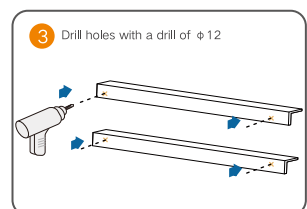
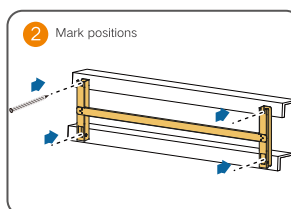
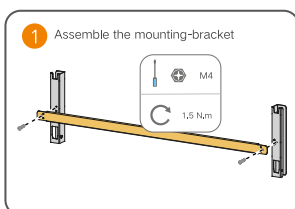

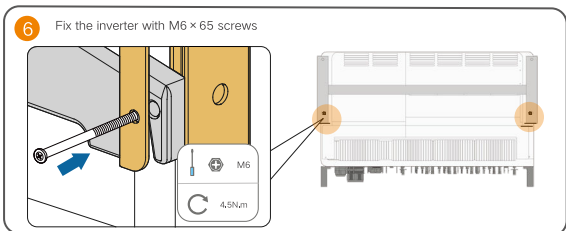
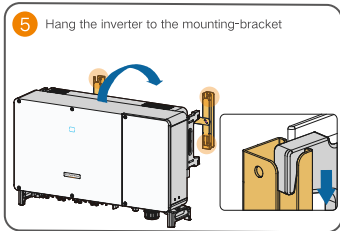
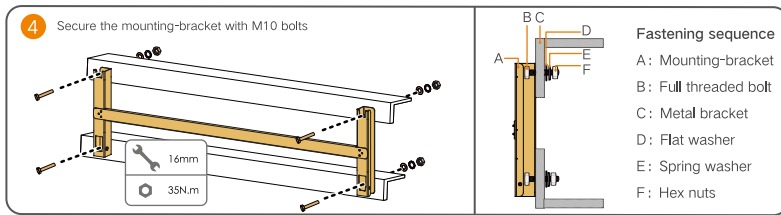

## 3 Electrical Connection

### Overview

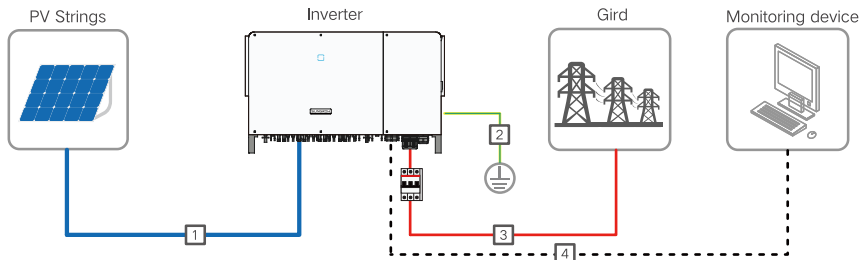

### 3-1 Cable requirements

No	Cable	Type	Outer diameter(mm)	Conductor cross section(mm <sup>2</sup> )
1	DC cable	PV cable complying with 1,500V standard	6~9	4~6
2	Additional grounding cable	Outdoor single-core copper wire cable	/	The same as that of the PE wire in the AC cable
		Four-core copper or aluminum cable	38~56	L1,L2,L3: 70~240 PE wire: Phase cable /2
3	AC cable	Four single-core outdoor copper or aluminum cables*	14~32	L1,L2,L3: 70~300 PE wire: Phase cable /2
4	Communication cable	Shielded twisted pair	4,5~18	1~1,5

\*If case of four single-core cables, an spare AC sealing plate accessory is required. To purchase the AC sealing plate accessory, contact SUNGROW.

#### ⚠ NOTICE

- The DC cable must be a multi-core cables.

## 3-2 Additional Grounding Connection

### ⚠ NOTICE

- Since the inverter is a transformerless inverter, neither the negative pole nor the positive pole of the PV string can be grounded. Otherwise, the inverter will not operate normally.
- There are two terminals. Use at least one of them to ground the inverter.
- Apply paint to the grounding terminal to ensure corrosion resistance after connection.

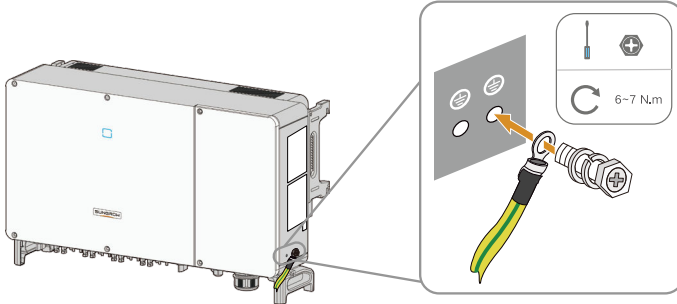

## 3-3 Opening the Wiring Compartment

**Step 1** Release two screws on the front cover of the wiring compartment with supplied Allen wrench. Open the wiring compartment.

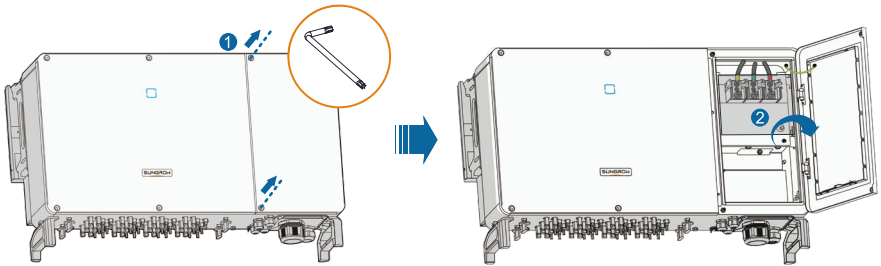

**Step 2** Keep the wiring compartment opened during wiring through the limit lever attached to the cover.

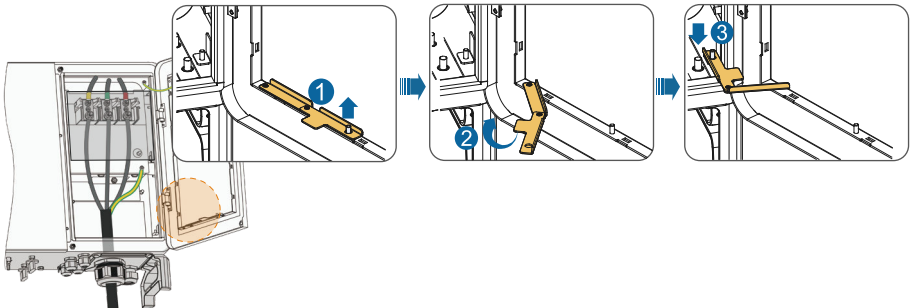

\*Close the wiring compartment in reverse order after completing wiring operations.

## 3-4 AC Connection

### ⚠ NOTICE

- Before connecting the inverter to the grid, ensure the grid voltage and frequency comply with requirements.
- Disconnect the AC-side circuit breaker and prevent it from inadvertent reconnection.
- Observe the pin assignment of AC terminal block. If a phase wire is connected to the "PE" terminal, it may permanently damage the inverter.
- Please avoid squeezing the cable insulation layer into the AC terminal. Improper connection may affect the normal operation of the inverter.
- During AC cable connection, the cables inside the lower part of the device should be bended to be surplus in length. In this way, cable dropping or loosening, which can cause arc or other problems impairing functionality of the device, due to self-weight of the cables in case of land subsidence is avoided.
- If an aluminium cable is selected, use a copper to aluminium adapter terminal to avoid direct contact between the copper bar and the aluminium cable. See user manual for more details.

**1** Lead the cable through the swivel nut

**2** Remove the protection cover and store the released screws properly.

**3** Strip the protection layer and insulation layer

**4** Install the heat shrink tubing and OT/DT terminal

**5** Crimp the OT/DT terminal

**6** Fixed heat shrink tubing

**7** Fix the AC cable to the corresponding terminals

**8** Fasten the swivel nut and reinstall the protection cover

## 3-5 DC connection

### ⚠ NOTICE

- Use the DC terminal within the scope of delivery. Damage to the device due to the use of incompatible terminal shall not be covered by the warranty.
- There is a risk of inverter damage! The following requirements should be met. Failure to do so will void guarantee and warranty claims.
  - (1) Ensure that the open circuit voltage in any case does not exceed the inverter input upper limit of 1500V.
  - (2) Make sure the maximum short circuit current on the DC side is within the permissible range.
  - (3) Make sure the to-ground insulation performance of the PV string is sound.
- The inverter will not function properly if the DC polarities are reversed.
- If the PV connectors are not assembled into place, it may cause an arc or overheat. The loss caused by this issue will void the warranty.

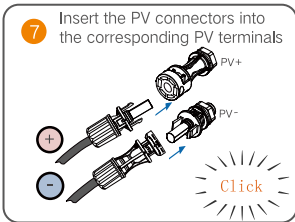
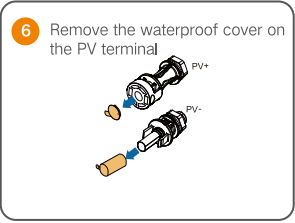
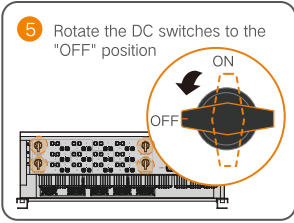
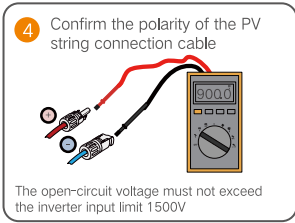
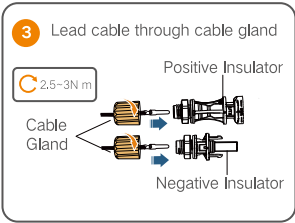
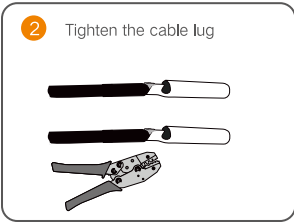
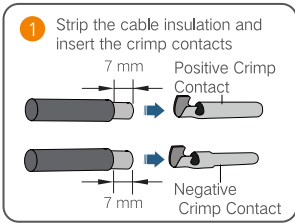

### 3-6 RS485 Communication Connection

The inverter is equipped with two groups of RS485 communication interfaces for external communication connection. Both the two groups of interfaces can be connected to the data collector (Logger), to achieve data exchange with PC or other monitoring devices. When multiple inverters are connected in the RS485 daisy chain, a 120Ω terminating resistor can be connected between the A and B communication cable through the RS485-dip switch, to ensure communication quality.

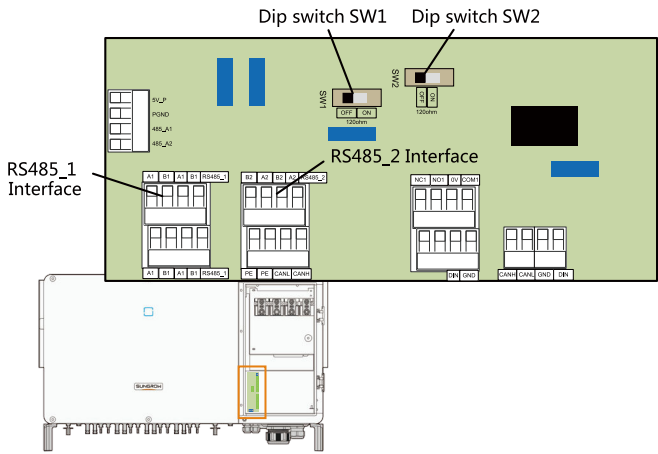

## Wiring procedure

- 1 Loosen the swivel nut of the communication terminal and select an appropriate seal

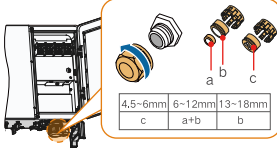

- 2 Lead the cable through the swivel nut



- 3 Strip the cable jacket and insulation layer

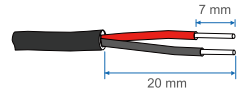

- 4 Secure the cable to the terminal base

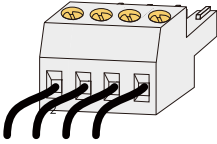

- 5 Insert the terminal base into the corresponding terminal

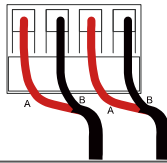

- 6 Fasten the swivel nut

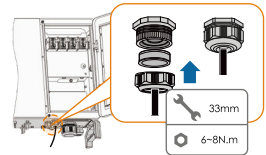

### ⚠ NOTICE

There are four RS485 communication terminals, and the marks are COM1/COM2/COM3/COM4, Please choose according to the actual situation,



# 4 Commission

## 4-1 Inspection before Commissioning

No.	Items	Result	
		Yes	No
1	The inverter should be accessible for operation, maintenance and service.	<input type="checkbox"/>	<input type="checkbox"/>
2	The inverter is firmly installed.	<input type="checkbox"/>	<input type="checkbox"/>
3	Nothing is left on the top of the inverter.	<input type="checkbox"/>	<input type="checkbox"/>
4	The inverter is correctly connected to the external devices.	<input type="checkbox"/>	<input type="checkbox"/>
5	The cables are routed in a safe place or protected against mechanical damage.	<input type="checkbox"/>	<input type="checkbox"/>
6	The specification of the AC circuit breaker is appropriate for its intended use.	<input type="checkbox"/>	<input type="checkbox"/>
7	All unused terminals at the bottom of the inverter are properly sealed.	<input type="checkbox"/>	<input type="checkbox"/>
8	Warning signs & labels are suitably affixed and durable.	<input type="checkbox"/>	<input type="checkbox"/>

## 4-2 Commissioning Procedure

**Step1** Rotate the DC switch to the “ON” position.

\*Skip performing step1 when the actual device is not equipped with DC switches.

**Step2** Connect the AC switch (if applicable) between the inverter and the grid.

**Step3** Connect the DC switch (if applicable) between the inverter and the PV string.

**Step4** Set initial protection parameters via the iSolarCloud APP. If the irradiation and grid conditions meet requirements, the inverter will normally operate.

**Step5** Observe the LED indicator to ensure that the inverter operates normally.

### LED indicator description

	Steady blue	The device is connected to the grid and operating normally.
	Periodical flashing blue (Period: 0.2s)	The Bluetooth communication is connected and there is data communication. No inverter fault occurs.
	Periodical flashing blue (Period: 2s)	The DC or AC side is powered on and the device is in standby or startup state (not feeding power into the grid).
	Steady red	A fault occurs and the device cannot connect to the grid.
	Flashing red	The Bluetooth communication is connected and there is data communication. Fault occurs.
	OFF	Both the AC and DC sides are powered down.

# 5 iSolarCloud

## 5-1 Brief Introduction

The iSolarCloud APP can establish communication connection to the inverter via the Bluetooth, thereby achieving near-end maintenance on the inverter. Users can use the APP to view basic information, alarms, and events, set parameters, or download logs, etc.

\*In case the communication module Eye or WiFi is available, the iSolarCloud APP can also establish communication connection to the inverter via the mobile data or WiFi, thereby achieving remote maintenance on the inverter.

## 5-2 Download and Install

**Method 1 :** Scan the right QR code to download and install the APP.

**Method 2 :** Download the APP through the following application stores:

- MyApp (Android, mainland China users)
- Google Play (Android, users other than mainland China ones)
- APP store ( iOS )



## 5-3 Initialize protection parameter

### ⚠ NOTICE

- To log in to the app, the following conditions must be met:
  - (1) The AC and DC sides or the AC side of the inverter is powered-on.
  - (2) The mobile phone is within 5m away from the inverter and there are no obstructions in between.
  - (3) The Bluetooth function of the mobile phone is enabled.

**Step1** After the installation is complete, click "Open" or click the phone desktop APP icon to open the app.

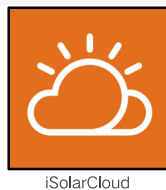

**Step2** Open the APP, after which the Bluetooth search screen pops up automatically, and select the to-be-connected inverter according the SN on the nameplate of the inverter. The Bluetooth indicator gets on once the connection is established. Alternatively, tap "☰" to scan the QR code on the side of the inverter to establish Bluetooth connection.

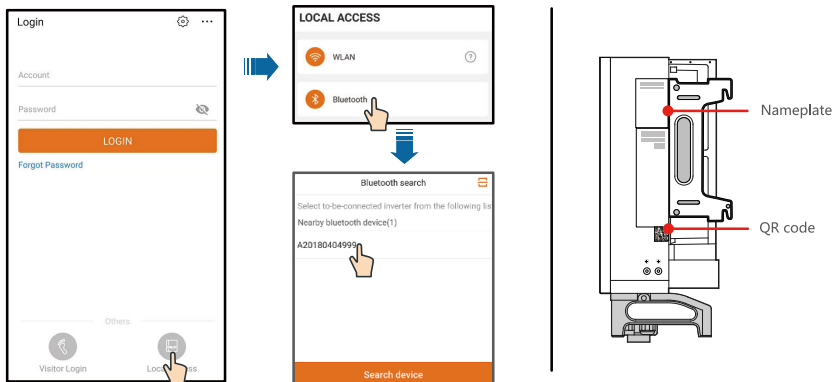

**Step3** Enter the username and login password, click Login and proceed to the next step.

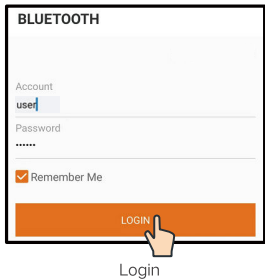

Login

**Step4** After logging in, enter the initialization protection parameter setting interface, as shown in the figure. After finishing setting on the quick setting screen, click “Boot” and the device will be initialized. The APP will send start instructions and the device will start and operate.



Initialization protection parameter

**NOTICE**

- The user name is "user" and the initial password is "pw1111". To ensure account security, please change the password as soon as possible.
- Reset the protection parameters if the country setting is incorrect. Otherwise, fault may occur.
- In European countries (regions), such as Netherlands, Sweden, Denmark, whose grid code complies with EN50549, select the parameter EN50549\_1 (LV grid-connection) or EN50549\_2 (MV grid-connection).
- In the Brazilian region, set the country code to "Brazil". Selecting "Brazil\_230" or "Brazil\_240" will cause setting failure.

**Step5** If the inverter is initialized, the APP automatically turns to its home page.

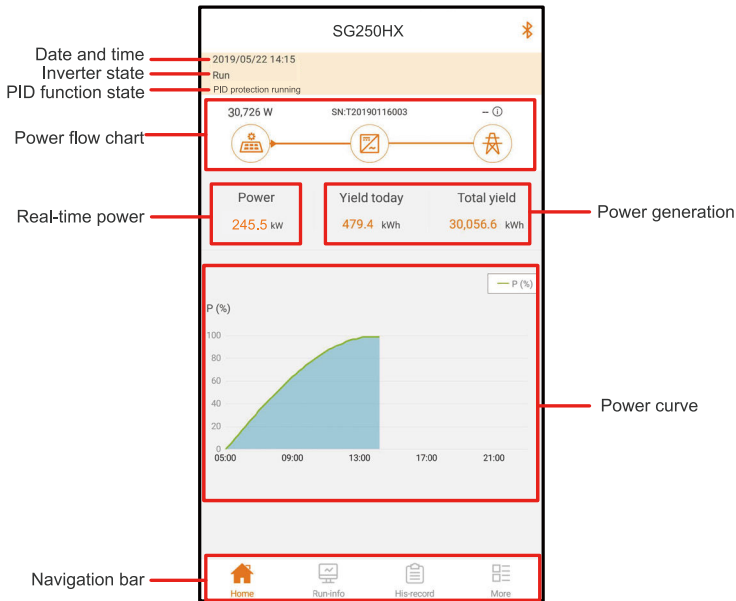

Home page

\*Screenshots in this manual are based on the Android system V2.1.6, and the actual interfaces may differ.



Sungrow Power Supply Co., Ltd.

Add: No. 1699 Xiyou Rd., New & High Technology Industrial Development Zone, 230088, Hefei, P. R. China.  
Web: [www.sungrowpower.com](http://www.sungrowpower.com)  
Tel: +86 551 6532 7834 / 6532 7845  
E-mail: [info@sungrow.cn](mailto:info@sungrow.cn)  
Fax: +86 551 6532 7856



More information in the QR code or  
at <http://support.sungrowpower.com/>

**SUNGROW**

Specifications are subject to changes without advance notice.



6891004HWNIEIO