

1 Eastron SDM630MCT Smart Meter Modbus Protocol Implementation V1.7

1.1 Modbus Protocol Overview

This section provides basic information for interfacing the Eastron Smart meter to a Modbus Protocol network. If background information or more details of the Eastron implementation is required please refer to section 2 and 3 of this document.

Easton offers the option of an RS485 communication facility for direct connection to SCADA or other communications systems using the Modbus Protocol RTU slave protocol. The Modbus Protocol establishes the format for the master's query by placing into it the device address, a function code defining the requested action, any data to be sent, and an error checking field. The slave's response message is also constructed using Modbus Protocol. It contains fields confirming the action taken, any data to be returned, and an error-checking field. If an error occurs in receipt of the message, SDM630MCT will make no response. If the SDM630 is unable to perform the requested action, it will construct an error message and send it as the response.

The electrical interface is 2-wire RS485, via 2 screw terminals. Connection should be made using twisted pair screened cable (Typically 22 gauge Belden 8761 or equivalent). All "A" and "B" connections are daisy chained together. Line topology may or may not require terminating loads depending on the type and length of cable used. Loop (ring) topology does not require any termination load. The impedance of the termination load should match the impedance of the cable and be at both ends of the line. The cable should be terminated at each end with a 120 ohm (0.25 Watt min.) resistor. A total maximum length of 3900 feet (1200 meters) is allowed for the RS485 network. A maximum of 32 electrical nodes can be connected, including the controller. The address of each Eastron can be set to any value between 1 and 247. Broadcast mode (address 0) is not supported.

The format for each byte in RTU mode is:

Coding System: 8-bit per byte
Data Format: 4 bytes (2 registers) per parameter.
Floating point format (to IEEE 754)
Most significant register first (Default). The default may be changed if required -See Holding Register "Register Order" parameter.
Error Check Field: 2 byte Cyclical Redundancy Check (CRC)
Framing: 1 start bit
8 data bits, least significant bit sent first
1 bit for even/odd parity (or no parity)
1 stop bit if parity is used; 1 or 2 bits if no parity

Data Coding

All data values in the SDM630MCT smart meter are transferred as 32 bit IEEE754 floating point numbers, (input and output) therefore each SDM630MCT meter value is transferred using two Modbus Protocol registers. All register read requests and data write requests must specify an even number of registers. Attempts to read/write an odd number of

registers prompt the SDM630MCT smart meter to return a Modbus Protocol exception message. However, for compatibility with some SCADA systems, SDM630MCT Smart meter will response to any single input or holding register read with an instrument type specific value.

The SDM630MCT can transfer a maximum of 30 values in a single transaction; therefore the maximum number of registers requestable is 60. Exceeding this limit prompts the SDM630MCT to generate an exception response.

Data transmission speed is selectable between 2400, 4800, 9600, 19200, 38400 baud.

1.2 Input register

Input registers are used to indicate the present values of the measured and calculated electrical quantities. Each parameter is held in two consecutive 16 bit register. The following table details the 3X register address, and the values of the address bytes within the message. A (*) in the column indicates that the parameter is valid for the particular wiring system. Any parameter with a cross(X) will return the value zero. Each parameter is held in the 3X registers. Modbus Protocol function code 04 is used to access all parameters.

For example, to request: Amps 1 Start address=0006
 No. of registers =0002
 Amps 2 Start address=0008
 No. of registers=0002

Each request for data must be restricted to 40 parameters or less. Exceeding the 40 parameter limit will cause a Modbus Protocol exception code to be returned.

1.2.1 SDM630MCT Input Registers

Address (Register)	Input Register Parameter				Modbus Protocol Start Address Hex		3 0	3 0	1 0
	Description	Length (bytes)	Data Format	Units	Hi Byte	Lo Byte	4 W	3 W	2 W
30001	Phase 1 line to neutral volts.	4	Float	V	00	00	√	X	√
30003	Phase 2 line to neutral volts.	4	Float	V	00	02	√	X	X
30005	Phase 3 line to neutral volts.	4	Float	V	00	04	√	X	X
30007	Phase 1 current.	4	Float	A	00	06	√	√	√
30009	Phase 2 current.	4	Float	A	00	08	√	√	X
30011	Phase 3 current.	4	Float	A	00	0A	√	√	X
30013	Phase 1 active power.	4	Float	W	00	0C	√	X	√

30015	Phase 2 active power.	4	Float	W	00	0E	√	X	X
30017	Phase 3 active power.	4	Float	W	00	10	√	X	X
30019	Phase 1 apparent power.	4	Float	VA	00	12	√	X	√
30021	Phase 2 apparent power.	4	Float	VA	00	14	√	X	X
30023	Phase 3 apparent power.	4	Float	VA	00	16	√	X	X
30025	Phase 1 reactive power.	4	Float	VAr	00	18	√	X	√
30027	Phase 2 reactive power.	4	Float	VAr	00	1A	√	X	X
30029	Phase 3 reactive power.	4	Float	VAr	00	1C	√	X	X
30031	Phase 1 power factor (1).	4	Float	None	00	1E	√	X	√
30033	Phase 2 power factor (1).	4	Float	None	00	20	√	X	X
30035	Phase 3 power factor (1).	4	Float	None	00	22	√	X	X
30037	Phase 1 phase angle.	4	Float	Degrees	00	24	√	X	√
30039	Phase 2 phase angle.	4	Float	Degrees	00	26	√	X	X
30041	Phase 3 phase angle.	4	Float	Degrees	00	28	√	X	X
30043	Average line to neutral volts.	4	Float	V	00	2A	√	X	X
30047	Average line current.	4	Float	A	00	2E	√	√	√
30049	Sum of line currents.	4	Float	A	00	30	√	√	√
30053	Total system power.	4	Float	W	00	34	√	√	√
30057	Total system volt amps.	4	Float	VA	00	38	√	√	√
30061	Total system VAr.	4	Float	VAr	00	3C	√	√	√
30063	Total system power factor (1).	4	Float	None	00	3E	√	√	√
30067	Total system phase angle.	4	Float	Degrees	00	42	√	√	√
30071	Frequency of supply voltages.	4	Float	Hz	00	46	√	√	√
30073	Total Import kWh	4	Float	kWh	00	48	√	√	√
30075	Total Export kWh.	4	Float	kWh	00	4A	√	√	√
30077	Total Import kVArh .	4	Float	kVArh	00	4C	√	√	√
30079	Total Export kVArh .	4	Float	kVArh	00	4E	√	√	√
30081	Total VAh	4	Float	kVAh	00	50	√	√	√

30083	Ah	4	Float	Ah	00	52	√	√	√
30085	Total system power demand (2) .	4	Float	W	00	54	√	√	√
30087	Maximum total system power demand (2).	4	Float	W	00	56	√	√	√
30101	Total system VA demand.	4	Float	VA	00	64	√	√	√
30103	Maximum total system VA demand.	4	Float	VA	00	66	√	√	√
30105	Neutral current demand.	4	Float	Amps	00	68	√	X	X
30107	Maximum neutral current demand.	4	Float	Amps	00	6A	√	X	X
30109	Total system reactive power demand. (2)	4	Float	VAr	00	6C	√	X	√
30111	Maximum total system reactive power demand(2)	4	Float	VAr	00	6E	√	X	√
30201	Line 1 to Line 2 volts.	4	Float	V	00	C8	√	√	X
30203	Line 2 to Line 3 volts.	4	Float	V	00	CA	√	√	X
30205	Line 3 to Line 1 volts.	4	Float	V	00	CC	√	√	X
30207	Average line to line volts.	4	Float	V	00	CE	√	√	X
30225	Neutral current.	4	Float	A	00	E0	√	X	X
30235	Phase 1 L/N volts THD	4	Float	%	00	EA	√	X	√
30237	Phase 2 L/N volts THD	4	Float	%	00	EC	√	X	X
30239	Phase 3 L/N volts THD	4	Float	%	00	EE	√	X	X
30241	Phase 1 Current THD	4	Float	%	00	F0	√	√	√
30243	Phase 2 Current THD	4	Float	%	00	F2	√	√	X
30245	Phase 3 Current THD	4	Float	%	00	F4	√	√	X
30249	Average line to neutral volts THD.	4	Float	%	00	F8	√	X	√
30251	Average line current THD.	4	Float	%	00	FA	√	√	√
30255	Total system power factor (1).	4	Float	Degrees	00	FE	√	√	√
30259	Phase 1 current demand.	4	Float	A	01	02	√	√	√
30261	Phase 2 current demand.	4	Float	A	01	04	√	√	X
30263	Phase 3 current demand.	4	Float	A	01	06	√	√	X
30265	Maximum phase 1 current demand.	4	Float	A	01	08	√	√	√
30267	Maximum phase 2 current demand.	4	Float	A	01	0A	√	√	X

30269	Maximum phase 3 current demand.	4	Float	A	01	0C	√	√	X
30335	Line 1 to line 2 volts THD.	4	Float	%	01	4E	√	√	X
30337	Line 2 to line 3 volts THD.	4	Float	%	01	50	√	√	X
30339	Line 3 to line 1 volts THD.	4	Float	%	01	52	√	√	X
30341	Average line to line volts THD.	4	Float	%	01	54	√	√	X
30343	Total kWh (3)	4	Float	kWh	01	56	√	√	√
30345	Total kVArh (3)	4	Float	kVArh	01	58	√	√	√
30347	L1 import kWh	4	Float	kWh	01	5A	√	√	√
30349	L2 import kWh	4	Float	kWh	01	5C	√	√	X
30351	L3 import kWh	4	Float	kWh	01	5E	√	√	X
30353	L1 export kWh	4	Float	kWh	01	60	√	√	√
30355	L2 export kWh	4	Float	kWh	01	62	√	√	X
30357	L3 export kWh	4	Float	kWh	01	64	√	√	X
30359	L1 total kWh	4	Float	kWh	01	66	√	√	√
30361	L2 total kWh	4	Float	kWh	01	68	√	√	X
30363	L3 total kWh	4	Float	kWh	01	6A	√	√	X
30365	L1 import kVArh	4	Float	kVArh	01	6C	√	√	√
30367	L2 import kVArh	4	Float	kVArh	01	6E	√	√	X
30369	L3 import kVArh	4	Float	kVArh	01	70	√	√	X
30371	L1 export kVArh	4	Float	kVArh	01	72	√	√	√
30373	L2 export kVArh	4	Float	kVArh	01	74	√	√	X
30375	L3 export kVArh	4	Float	kVArh	01	76	√	√	X
30377	L1 total kVArh	4	Float	kVArh	01	78	√	√	√
30379	L2 total kVArh	4	Float	kVArh	01	7A	√	√	X
30381	L3 total kVArh	4	Float	kVArh	01	7C	√	√	X
30385	resettable total active energy	4	Float	kWh	01	80	√	√	√
30387	resettable total reactive energy	4	Float	kVArh	01	82	√	√	√
30389	resettable import active energy	4	Float	kWh	01	84	√	√	√

30391	resettable export active energy	4	Float	kWh	01	86	√	√	√
30393	resettable import reactive energy	4	Float	kVArh	01	88	√	√	√
30395	resettable export reactive energy	4	Float	kVArh	01	8A	√	√	√

Notes:

1. The power factor has its sign adjusted to indicate the direction of the current. Positive refers to forward current, negative refers to reverse current.
2. The power sum demand calculation is for import – export.
3. Total kWh / kVArh equals to Import + export.

1.3 Modbus Protocol Holding Registers and Digital meter set up

Holding registers are used to store and display instrument configuration settings. All holding registers not listed in the table below should be considered as reserved for manufacturer use and no attempt should be made to modify their values.

The holding register parameters may be viewed or changed using the Modbus Protocol. Each parameter is held in two consecutive 4X registers. Modbus Protocol Function Code 03 is used to read the parameter and Function Code 16 is used to write. Write to only one parameter per message.

1.3.1 SDM630MCT MODBUS Protocol Holding Register Parameters

Address Register	Parameter Number	Parameter	Modbus Protocol Start Address Hex		Valid range	Mode
			High Byte	Low Byte		
40001	1	Demand Time	00	00	Read minutes into first demand calculation. When the demand time reaches the demand Period then the demand values are valid. Length : 4 byte Data Format : Float	ro
40003	2	Demand Period	00	02	Write demand period: 0, 5,8, 10, 15, 20, 30 or 60 minutes, default 60. Setting the period to 0 will cause the demand to show the current parameter value, and demand max to show the maximum parameter value since last demand reset. Length : 4 byte Data Format : Float	r/w
40011	6	System Type	00	0A	Write system type: 3p4w = 3, 3p3w = 2 & 1p2w= 1 Requires password, see parameter 13	r/w

					Length : 4 byte Data Format : Float	
40013	7	Pulse output 1 Width	00	OC	Write relay on period in milliseconds: 60, 100 or 200, default 200. Length : 4 byte Data Format : Float	r/w
40015	8	Password Lock	00	OE	Read password lock status: 0 = locked. 1 = unlocked. Length : 4 byte Data Format : Float	ro
40019	10	Parity Stop	00	12	Write the parity/stop bits for MODBUS Protocol, where: 0 = One stop bit and no parity, default. 1 = One stop bit and even parity. 2 = One stop bit and odd parity. 3 = Two stop bits and no parity. Length : 4 byte Data Format : Float	r/w
40021	11	Modbus Address	00	14	Write the Modbus Address address: 1 to 247 for MODBUS Protocol, default 1. Note, both the MODBUS node addresses can be changed via the display setup menus. Length : 4 byte Data Format : Float	r/w
40023	12	Pulse 1 Divisor	00	16	Write pulse divisor index: n = 1 to 6 1--0.01kwh/imp 2--0.1kwh/imp 3--1kwh/imp 4-10kwh/imp 5-100kwh/imp 6-1000kwh/imp Length : 4 byte Data Format : Float	r/w
40025	13	Password	00	18	Write password for access to protected registers. Default password is 1000. Length : 4 byte Data Format : Float	r/w

40029	15	Baud Rate	00	1C	Write the baud rate for MODBUS Protocol, where: 0 = 2400 baud. 1 = 4800 baud. 2 = 9600 baud, default. 3 = 19200 baud. 4 = 38400 baud. Length : 4 byte Data Format : Float	r/w
		CT2	00	34	CT 2: 1 or 5 Length : 4 byte Data Format : Float	r/w
40063	32	CT ratio	00	3E	CT Ratio range:1~2000 CT Ratio= primary current /secondary current Length : 4 byte Data Format : Float Requires password, see parameter 13 (Non MID)	r/w
		PT2	00	30	PT 2: 230V Length : 4 byte Data Format : Float	r/w
40065	33	PT ratio	00	40	PT Ratio range:1~2000 PT ratio= primary voltage /secondary voltage Length : 4 byte Data Format : Float Requires password, see parameter 13 (Non MID)	r/w
40087	44	Pulse 1 Energy Type	00	56	Write MODBUS Protocol input parameter for pulse out 1: 37 = total kwh or 39 = total kVarh, default 39. Length : 4 byte Data Format : Float	r/w
461457	30729	Reset	F0	10	00 00 : reset the Maximum demand 00 03: reset the resettable energy Length : 2 byte Data Format:Hex	wo
464513	32257	Serial number	FC	00	Serial number Length: 4 byte Data Format: unsigned int32 Note: Only read	ro

464515	32258	Meter code	FC	02	Meter code = 00 79 Length: 2 bytes Data Format: Hex Note: read only	ro
464516	32259	Software version	FC	03	Software version Length: 2 bytes Data Format: Hex Note: read only	ro

Register Order controls the order in which the Eastron Digital meter receives or sends floating-point numbers: - normal or reversed register order. In normal mode, the two registers that make up a floating point number are sent most significant register first. In reversed register mode, the two registers that make up a floating point number are sent least significant register first. To set the mode, write the value '2141.0' into this register - the instrument will detect the order used to send this value and set that order for all Modbus Protocol transactions involving floating point numbers.

It is perfectly feasible to change Eastron Digital meter set-up using a general purpose Modbus Protocol master, but often easier to use the Eastron Digital meter display or Eastron Digital meter configurator software, especially for gaining password protected access. The Eastron Digital meter configurator software has facilities to store configurations to disk for later retrieval and rapid set up of similarly configured products.

Password

Some of the parameters described above are password protected and thus require the password to be entered at the Password register before they can be changed. The default password is 0000. When the password has been entered it will timeout in one minute unless the Password or Password Lock register is read to reset the timeout timer. Once the required changes have been made to the protected parameters the password lock should be reapplied by

- a) allowing the password to timeout, or
- b) writing any value to the Password Lock register, or
- c) power cycling the instrument.

2 RS485 General Information

Some of the information in this section relates to other Eastron Digital meter product families, and is included to assist where a mixed network is implemented. RS485 or EIA (Electronic Industries Association) RS485 is a balanced line, half-duplex transmission system allowing transmission distances of up to 1.2 km. The following table summarizes the RS-485 Standard:

PARAMETER	
Mode of Operation	Differential
Number of Drivers and Receivers	32 Drivers, 32 Receivers

Maximum Cable Length	1200 m
Maximum Data Rate	10 M baud
Maximum Common Mode Voltage	12 V to -7 V
Minimum Driver Output Levels (Loaded)	+/- 1.5 V
Minimum Driver Output Levels (Unloaded)	+/- 6 V
Drive Load	Minimum 60 ohms
Driver Output Short Circuit Current Limit	150 mA to Gnd, 250 mA to 12 V 250 mA to -7 V
Minimum Receiver Input Resistance	12 kohms
Receiver Sensitivity	+/- 200 mV

Further information relating to RS485 may be obtained from either the EIA or the various RS485 device manufacturers, for example Texas Instruments or Maxim Semiconductors. This list is not exhaustive.

2.1 Half Duplex

Half duplex is a system in which one or more transmitters (talkers) can communicate with one or more receivers (listeners) with only one transmitter being active at any one time. For example, a “conversation” is started by asking a question, the person who has asked the question will then listen until he gets an answer or until he decides that the individual who was asked the question is not going to reply.

In a 485 network the “master” will start the “conversation” with a “query” addressed to a specific “slave”, the “master” will then listen for the “slave’s” response. If the “slave” does not respond within a pre-defined period, (set by control software in the “master”), the “master” will abandon the “conversation”.

2.2 Connecting the Instruments

If connecting an RS485 network to a PC use caution if contemplating the use of an RS232 to 485 converter together with a USB to RS485 adapter. Consider either an RS232 to RS485 converter, connected directly to a suitable RS232 jack on the PC, or use a USB to RS485 converter or, for desktop PCs a suitable plug in RS485 card. *(Many 232:485 converters draw power from the RS232 socket. If using a USB to RS232 adapter, the adapter may not have enough power available to run the 232:485 converter.)*

Screened twisted pair cable should be used. For longer cable runs or noisier environments, use of a cable specifically designed for RS485 may be necessary to achieve optimum performance. All “A” terminals should be connected together using one conductor of the twisted pair cable, all “B” terminals should be connected together using the other conductor in the pair. The cable screen should be connected to the “Gnd” terminals.

A Belden 9841 (Single pair) or 9842 (Two pair) or similar cable with a characteristic impedance of 120 ohms is recommended. The cable should be terminated at each end with a 120 ohm, quarter watt (or greater) resistor. Note: Diagram shows wiring topology only. Always follow terminal identification on Eastron Digital meter product label.

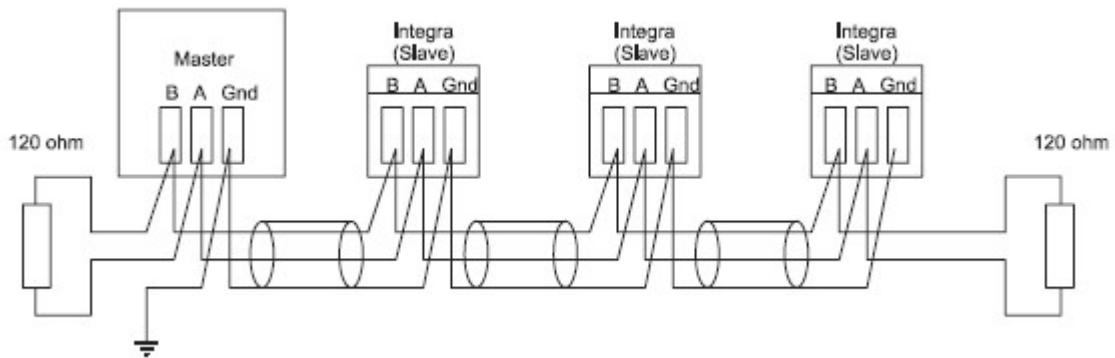

There must be no more than two wires connected to each terminal, this ensures that a “Daisy Chain or “straight line” configuration is used. A “Star” or a network with “Stubs (Tees)” is not recommended as reflections within the cable may result in data corruption.

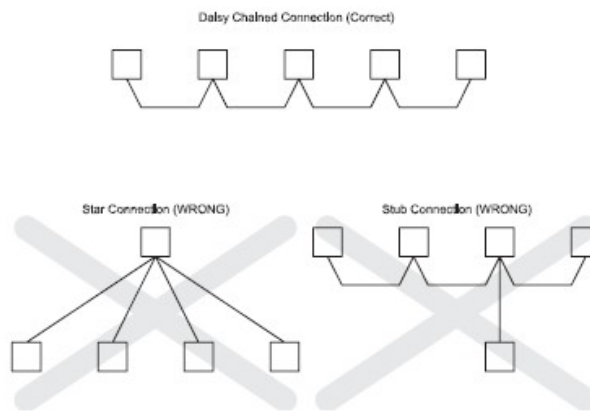

2.3 A and B terminals

The A and B connections to the Eastron Digital meter products can be identified by the signals present on them whilst there is activity on the RS485 bus:

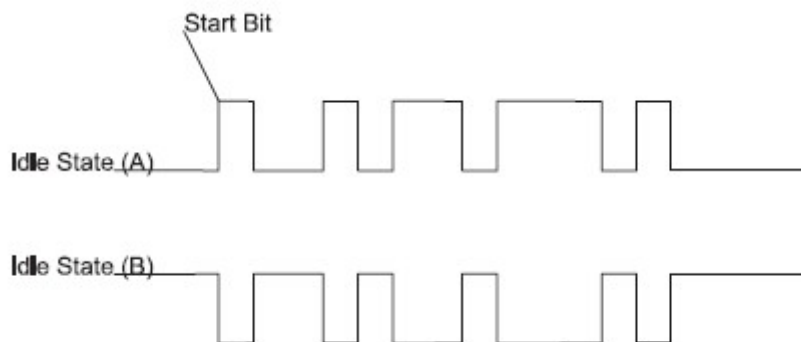

2.4 Troubleshooting

- Start with a simple network, one master and one slave. With Eastron Digital meter products this is easily achieved as the network can be left intact whilst individual instruments are disconnected by removing the RS485 connection from the rear of the instrument.
- Check that the network is connected together correctly. That is all of the “A’s” are connected together, and all of the “B’s” are connected together, and also that all of the “Gnd’s” are connected together.

- Confirm that the data “transmitted” onto the RS485 is not echoed back to the PC on the RS232 lines.(This facility is sometimes a link option within the converter). Many PC based packages seem to not perform well when they receive an echo of the message they are transmitting. SpecView and PCView (PC software) with a RS232 to RS485 converter are believed to include this feature.
- Confirm that the Address of the instrument is the same as the “master” is expecting.
- If the “network” operates with one instrument but not more than one check that each instrument has a unique address.
- Each request for data must be restricted to 40 parameters or less. Violating this requirement will impact the performance of the instrument and may result in a response time in excess of the specification.
- Check that the MODBUS Protocol mode (RTU or ASCII) and serial parameters (baud rate, number of data bits, number of stop bits and parity) are the same for all devices on the network.
- Check that the “master” is requesting floating-point variables (pairs of registers placed on floating point boundaries) and is not “splitting” floating point variables.
- Check that the floating-point byte order expected by the “master” is the same as that used by Eastron Digital meter products. (PCView and Citect packages can use a number of formats including that supported by Eastron Digital meter).
- If possible obtain a second RS232 to RS485 converter and connect it between the RS485 bus and an additional PC equipped with a software package, which can display the data on the bus. Check for the existence of valid requests.

3 MODBUS Protocol General Information

Communication on a MODBUS Protocol Network is initiated (started) by a “Master” sending a query to a “Slave”. The “Slave“, which is constantly monitoring the network for queries addressed to it, will respond by performing the requested action and sending a response back to the “Master”. Only the “Master” can initiate a query.

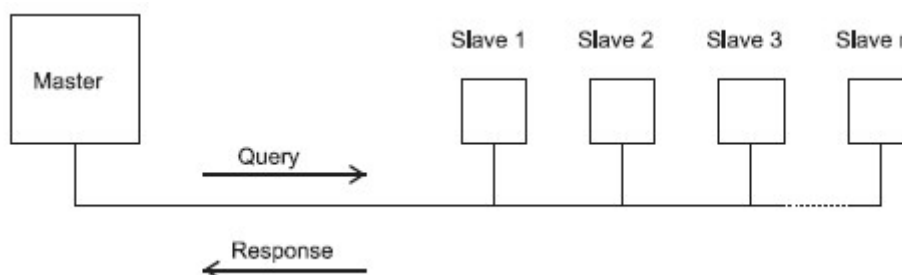

In the MODBUS Protocol the master can address individual slaves, or, using a special “Broadcast” address, can initiate a broadcast message to all slaves. The Eastron Digital meter do not support the broadcast address.

3.1 MODBUS Protocol Message Format

The MODBUS Protocol defines the format for the master’s query and the slave’s response. The query contains the device (or broadcast) address, a function code defining the requested

action, any data to be sent, and an error-checking field.

The response contains fields confirming the action taken, any data to be returned, and an error-checking field. If an error occurred in receipt of the message then the message is ignored, if the slave is unable to perform the requested action, then it will construct an error message and send it as its response. The MODBUS Protocol functions used by the Eastron Digital meters copy 16 bit register values between master and slaves. However, the data used by the Eastron Digital meter is in 32 bit IEEE 754 floating point format. Thus each instrument parameter is conceptually held in two adjacent MODBUS Protocol registers. Query
The following example illustrates a request for a single floating point parameter i.e. two 16-bit Modbus Protocol Registers.

First Byte							Last Byte	
Slave Address	Function Code	Start Address (Hi)	Start Address (Lo)	Number of Points (Hi)	Number of Points (Lo)	Number of Points (Lo)	Error Check (Lo)	Error Check (Hi)

Slave Address: 8-bit value representing the slave being addressed (1 to 247), 0 is reserved for the broadcast address. The Eastron Digital meters do not support the broadcast address.

Function Code: 8-bit value telling the addressed slave what action is to be performed. (3, 4, 8 or 16 are valid for Eastron Digital meter)

Start Address (Hi): The top (most significant) eight bits of a 16-bit number specifying the start address of the data being requested.

Start Address (Lo): The bottom (least significant) eight bits of a 16-bit number specifying the start address of the data being requested. As registers are used in pairs and start at zero, then this must be an even number.

Number of Points (Hi): The top (most significant) eight bits of a 16-bit number specifying the number of registers being requested.

Number of Points (Lo): The bottom (least significant) eight bits of a 16-bit number specifying the number of registers being requested. As registers are used in pairs, then this must be an even number.

Error Check (Lo): The bottom (least significant) eight bits of a 16-bit number representing the error check value.

Error Check (Hi): The top (most significant) eight bits of a 16-bit number representing the error check value.

Response

The example illustrates the normal response to a request for a single floating point parameter i.e. two 16-bit Modbus Protocol Registers.

First Byte							Last Byte	
Slave Address	Function Code	Byte Count	First Register (Hi)	First Register (Lo)	Second Register (Hi)	Second Register (Lo)	Error Check (Lo)	Error Check (Hi)

Slave Address: 8-bit value representing the address of slave that is responding.

Function Code: 8-bit value which, when a copy of the function code in the query, indicates that the slave recognised the query and has responded. (See also Exception Response).

Byte Count: 8-bit value indicating the number of data bytes contained within this response

First Register (Hi)*: The top (most significant) eight bits of a 16-bit number representing the first register requested in the query.

First Register (Lo)*: The bottom (least significant) eight bits of a 16-bit number representing the first register requested in the query.

Second Register (Hi)*: The top (most significant) eight bits of a 16-bit number representing the second register requested in the query.

Second Register (Lo)*: The bottom (least significant) eight bits of a 16-bit number representing the second register requested in the query.

Error Check (Lo): The bottom (least significant) eight bits of a 16-bit number representing the error check value.

Error Check (Hi): The top (most significant) eight bits of a 16-bit number representing the error check value.

*These four bytes together give the value of the floating point parameter requested.

Exception Response

If an error is detected in the content of the query (excluding parity errors and Error Check mismatch), then an error response (called an exception response), will be sent to the master. The exception response is identified by the function code being a copy of the query function code but with the most-significant bit set. The data contained in an exception response is a single byte error code.

First Byte

Last Byte

Slave Address	Function Code	Error Code	Error Check (Lo)	Error Check (Hi)
---------------	---------------	------------	------------------	------------------

Slave Address: 8-bit value representing the address of slave that is responding.

Function Code: 8 bit value which is the function code in the query OR'ed with 80 hex, indicating that the slave either does not recognise the query or could not carry out the action requested.

Error Code: 8-bit value indicating the nature of the exception detected. (See "Table Of Exception Codes" later).

Error Check (Lo): The bottom (least significant) eight bits of a 16-bit number representing the error check value.

Error Check (Hi): The top (most significant) eight bits of a 16-bit number representing the error check value.

3.2 Serial Transmission Modes

There are two MODBUS Protocol serial transmission modes, ASCII and RTU. Eastron Digital meters do not support the ASCII mode.

In RTU (Remote Terminal Unit) mode, each 8-bit byte is used in the full binary range and is not limited to ASCII characters as in ASCII Mode. The greater data density allows better data throughput for the same baud rate, however each message must be transmitted in a continuous stream. This is very unlikely to be a problem for modern communications equipment.

Coding System: Full 8-bit binary per byte. In this document, the value of each byte will be shown as two hexadecimal characters each in the range 0-9 or A-F.

Line Protocol: 1 start bit, followed by the 8 data bits. The 8 data bits are sent with least significant bit first.

User Option Of Parity No Parity and 2 Stop Bits

And Stop Bits: No Parity and 1 Stop Bit

Even Parity and 1 Stop Bit

Odd Parity and 1 Stop Bit.

User Option of Baud 4800 ; 9600 ; 19200 ; 38400

Rate: Digital meters do not support 38400 but do offer 2400 instead)

The baud rate, parity and stop bits must be selected to match the master's settings.

3.3 MODBUS Protocol Message Timing (RTU Mode)

A MODBUS Protocol message has defined beginning and ending points. The receiving devices recognizes the start of the message, reads the "Slave Address" to determine if they are being addressed and knowing when the message is completed they can use the Error Check bytes and parity bits to confirm the integrity of the message. If the Error Check or parity fails then the message is discarded.

In RTU mode, messages starts with a silent interval of at least 3.5 character times.

The first byte of a message is then transmitted, the device address.

Master and slave devices monitor the network continuously, including during the 'silent' intervals. When the first byte (the address byte) is received, each device checks it to find out if it is the addressed device. If the device determines that it is the one being addressed it records the whole message and acts accordingly, if it is not being addressed it continues monitoring for the next message.

Following the last transmitted byte, a silent interval of at least 3.5 character times marks the end of the message. A new message can begin after this interval.

In the Eastron 1000 and 2000, a silent interval of 60msec minimum is required in order to guarantee successful reception of the next request.

The entire message must be transmitted as a continuous stream. If a silent interval of more than 1.5 character times occurs before completion of the message, the receiving device flushes the incomplete message and assumes that the next byte will be the address byte of a new message.

Similarly, if a new message begins earlier than 3.5 character times following a previous message, the receiving device may consider it a continuation of the previous message. This will result in an error, as the value in the final CRC field will not be valid for the combined

messages.

3.4 How Characters are Transmitted Serially

When messages are transmitted on standard MODBUS Protocol serial networks each byte is sent in this order (left to right):

Transmit Character = Start Bit + Data Byte + Parity Bit + 1 Stop Bit (11 bits total):

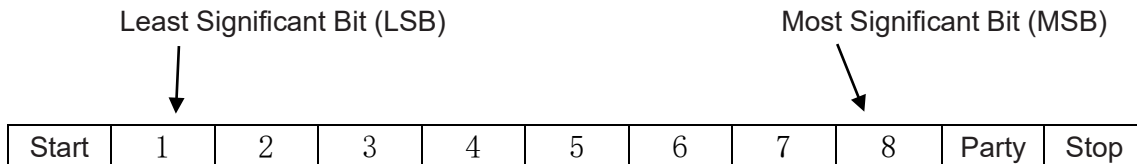

Transmit Character = Start Bit + Data Byte + 2 Stop Bits (11 bits total):

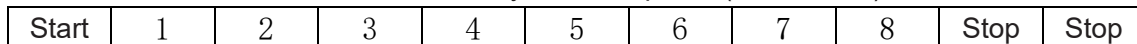

Eastron Digital meters additionally support No parity, One stop bit.

Transmit Character = Start Bit + Data Byte + 1 Stop Bit (10 bits total):

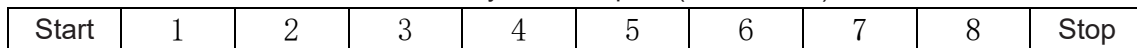

The master is configured by the user to wait for a predetermined timeout interval. The master will wait for this period of time before deciding that the slave is not going to respond and that the transaction should be aborted. Care must be taken when determining the timeout period from both the master and the slaves' specifications. The slave may define the 'response time' as being the period from the receipt of the last bit of the query to the transmission of the first bit of the response. The master may define the 'response time' as period between transmitting the first bit of the query to the receipt of the last bit of the response. It can be seen that message transmission time, which is a function of the baud rate, must be included in the timeout calculation.

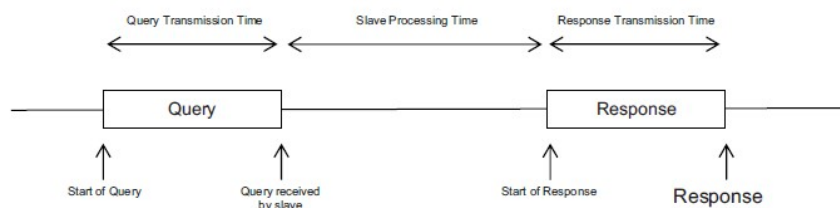

3.5 Error Checking Methods

Standard MODBUS Protocol serial networks use two error checking processes, the error check bytes mentioned above check message integrity whilst Parity checking (even or odd) can be applied to each byte in the message.

3.5.1 Parity Checking

If parity checking is enabled – by selecting either Even or Odd Parity - the quantity of “1’s” will be counted in the data portion of each transmit character. The parity bit will then be set to a 0 or 1 to result in an Even or Odd total of “1’s”.

Note that parity checking can only detect an error if an odd number of bits are picked up or

dropped in a transmit character during transmission, if for example two 1's are corrupted to 0's the parity check will not find the error.

If No Parity checking is specified, no parity bit is transmitted and no parity check can be made. Also, if No Parity checking is specified and one stop bit is selected the transmit character is effectively shortened by one bit.

3.5.2 CRC Checking

The error check bytes of the MODBUS Protocol messages contain a Cyclical Redundancy Check (CRC) value that is used to check the content of the entire message. The error check bytes must always be present to comply with the MODBUS Protocol, there is no option to disable it.

The error check bytes represent a 16-bit binary value, calculated by the transmitting device. The receiving device must recalculate the CRC during receipt of the message and compare the calculated value to the value received in the error check bytes. If the two values are not equal, the message should be discarded.

The error check calculation is started by first pre-loading a 16-bit register to all 1's (i.e. Hex (FFFF)) each successive 8-bit byte of the message is applied to the current contents of the register. Note: only the eight bits of data in each transmit character are used for generating the CRC, start bits, stop bits and the parity bit, if one is used, are not included in the error check bytes.

During generation of the error check bytes, each 8-bit message byte is exclusive OR'ed with the lower half of the 16 bit register. The register is then shifted eight times in the direction of the least significant bit (LSB), with a zero filled into the most significant bit (MSB) position. After each shift the LSB prior to the shift is extracted and examined. If the LSB was a 1, the register is then exclusive OR'ed with a pre-set, fixed value. If the LSB was a 0, no exclusive OR takes place.

This process is repeated until all eight shifts have been performed. After the last shift, the next 8-bit message byte is exclusive OR'ed with the lower half of the 16 bit register, and the process repeated. The final contents of the register, after all the bytes of the message have been applied, is the error check value. In the following pseudo code "Error Word" is a 16-bit value representing the error check values.

```
BEGIN
    Error Word = Hex (FFFF)
    FOR Each byte in message
        Error Word = Error Word XOR byte in message
        FOR Each bit in byte
            LSB = Error Word AND Hex (0001)
            IF LSB = 1 THEN Error Word = Error Word - 1
            Error Word = Error Word / 2
            IF LSB = 1 THEN Error Word = Error Word XOR Hex (A001)
        NEXT bit in byte
    NEXT Byte in message
END
```

3.6 Function Codes

The function code part of a MODBUS Protocol message defines the action to be taken by the slave. Eastron Digital meters support the following function codes:

Code	MODBUS Protocol name	Description
03	Read Holding Registers	Read the contents of read/write location(4X references)
04	Read Input Registers	Read the contents of read only location(3X references)
08	Diagnostics	Only sub-function zero is supported. This returns the data element of the query unchanged.
15	Pre-set Multiple Registers	Set the contents of read/write location (4X references)

3.7 IEEE floating point format

The MODBUS Protocol defines 16 bit “Registers” for the data variables. A 16-bit number would prove too restrictive, for energy parameters for example, as the maximum range of a 16-bit number is 65535.

However, there are a number of approaches that have been adopted to overcome this restriction. Eastron Digital meters use two consecutive registers to represent a floating-point number, effectively expanding the range to +/- 1×10^{37} .

The values produced by Eastron Digital meters can be used directly without any requirement to “scale” the values, for example, the units for the voltage parameters are volts, the units for the power parameters are watts etc.

What is a floating point Number?

A floating-point number is a number with two parts, a mantissa and an exponent and is written in the form 1.234×10^5 . The mantissa (1.234 in this example) must have the decimal point moved to the right with the number of places determined by the exponent (5 places in this example) i.e. $1.234 \times 10^5 = 123400$. If the exponent is negative the decimal point is moved to the left.

What is an IEEE 754 format floating-point number?

An IEEE 754 floating point number is the binary equivalent of the decimal floating-point number shown above. The major difference being that the most significant bit of the mantissa is always arranged to be 1 and is thus not needed in the representation of the number. The process by which the most significant bit is arranged to be 1 is called normalization, the mantissa is thus referred to as a “normal mantissa”. During normalization the bits in the mantissa are shifted to the left whilst the exponent is decremented until the most significant bit of the mantissa is one. In the special case where the number is zero both mantissa and exponent are zero.

The bits in an IEEE 754 format have the following significance:

Data Hi Reg, Hi Byte.	Data Hi Reg, Lo Byte.	Data Lo Reg, Hi Byte.	Data Lo Reg, Lo Byte.
--------------------------	--------------------------	--------------------------	--------------------------

SEEE EEEE	EMMM MMMM	MMMM MMMM	MMMM MMMM
----------------------------	----------------------------	----------------------------	----------------------------

Where:

S represents the sign bit where 1 is negative and 0 is positive

E is the 8-bit exponent with an offset of 127 i.e. an exponent of zero is represented by 127, an exponent of 1 by 128 etc.

M is the 23-bit normal mantissa. The 24th bit is always 1 and, therefore, is not stored.

Using the above format the floating point number 240.5 is represented as 43708000 hex:

Data Hi Reg, Hi Byte	Data Hi Reg, Lo Byte	Data Lo Reg, Hi Byte	Data Lo Reg, Lo Byte
43	70	80	00

The following example demonstrates how to convert IEEE 754 floating-point numbers from their hexadecimal form to decimal form. For this example, we will use the value for 240.5 shown above

Note that the floating-point storage representation is not an intuitive format. To convert this value to decimal, the bits should be separated as specified in the floating-point number storage format table shown above.

For example:

Data Hi Reg, Hi Byte	Data Hi Reg, Lo Byte	Data Lo Reg, Hi Byte	Data Lo Reg, Lo Byte
0100 0011	0111 0000	1000 0000	0000 0000

From this you can determine the following information.

- The sign bit is 0, indicating a positive number.
- The exponent value is 10000110 binary or 134 decimal. Subtracting 127 from 134 leaves 7, which is the actual exponent.
- The mantissa appears as the binary number 11100001000000000000000

There is an implied binary point at the left of the mantissa that is always preceded by a 1. This bit is not stored in the hexadecimal representation of the floating-point number. Adding 1 and the binary point to the beginning of the mantissa gives the following:

1.111000010000000000000000

Now, we adjust the mantissa for the exponent. A negative exponent moves the binary point to the left. A positive exponent moves the binary point to the right. Because the exponent is 7, the mantissa is adjusted as follows:

11110000.1000000000000000

Finally, we have a binary floating-point number. Binary bits that are to the left of the binary point represent

the power of two corresponding to their position. For example, 11110000 represents $(1 \times 2^7) + (1 \times 2^6) + (1 \times 2^5) + (1 \times 2^4) + (0 \times 2^3) + (0 \times 2^2) + (0 \times 2^1) + (0 \times 2^0) = 240$.

Binary bits that are to the right of the binary point also represent a power of 2 corresponding to

their position. As the digits are to the right of the binary point the powers are negative. For example: .100 represents $(1 \times 2^{-1}) + (0 \times 2^{-2}) + (0 \times 2^{-3}) + \dots$ which equals 0.5. Adding these two numbers together and making reference to the sign bit produces the number +240.5.

For each floating point value requested two MODBUS Protocol registers (four bytes) must be requested. The received order and significance of these four bytes for Eastron Digital meters is shown below:

Data Hi Reg, Hi Byte	Data Hi Reg, Lo Byte	Data Lo Reg, Hi Byte	Data Lo Reg, Lo Byte
---------------------------------	---------------------------------	---------------------------------	---------------------------------

3.8 MODBUS Protocol Commands supported

All Eastron Digital meters support the “Read Input Register” (3X registers), the “Read Holding Register” (4X registers) and the “Pre-set Multiple Registers” (write 4X registers) commands of the MODBUS Protocol RTU protocol. All values stored and returned are in floating point format to IEEE 754 with the most significant register first.

3.8.1 Read Input Registers

MODBUS Protocol code 04 reads the contents of the 3X registers.

Example

The following query will request ‘Volts 1’ from an instrument with node address 1:

Field Name	Example(Hex)
Slave Address	01
Function	04
Starting Address High	00
Starting Address Low	00
Number of Points High	00
Number of Points Low	02
Error Check Low	71
Error Check High	CB

Note: Data must be requested in register pairs i.e. the “Starting Address” and the “Number of Points” must be even numbers to request a floating point variable. If the “Starting Address” or the “Number of points” is odd then the query will fall in the middle of a floating point variable the product will return an error message.

The following response returns the contents of Volts 1 as 230.2. But see also “Exception Response” later.

Field Name	Example (Hex)
Slave Address	01
Function	04
Byte Count	04
Data, High Reg, High Byte	43
Data, High Reg, Low Byte	66

Data, Low Reg, High Byte	33
Data, Low Reg, Low Byte	34
Error Check Low	1B
Error Check High	38

3.9 Holding Registers

3.9.1 Read Holding Registers

MODBUS Protocol code 03 reads the contents of the 4X registers.

Example

The following query will request the prevailing 'Demand Time':

Field Name	Example (Hex)
Slave Address	01
Function	03
Starting Address High	00
Starting Address Low	00
Number of Points High	00
Number of Points Low	02
Error Check Low	C4
Error Check High	0B

Note: Data must be requested in register pairs i.e. the "Starting Address" and the "Number of Points" must be even numbers to request a floating point variable. If the "Starting Address" or the "Number of points" is odd then the query will fall in the middle of a floating point variable the product will return an error message.

The following response returns the contents of Demand Time as 1, But see also "Exception Response" later.

Field Name	Example (Hex)
Slave Address	01
Function	03
Byte Count	04
Data, High Reg, High Byte	3F
Data, High Reg, Low Byte	80
Data, Low Reg, High Byte	00
Data, Low Reg, Low Byte	00
Error Check Low	F7
Error Check High	CF

3.9.2 Write Holding Registers

MODBUS Protocol code 10 (16 decimal) writes the contents of the 4X registers.

Example

The following query will set the Demand Period to 60, which effectively resets the Demand Time:

Field Name	Example (Hex)
Slave Address	01
Function	10
Starting Address High	00
Starting Address Low	02
Number of Registers High	00
Number of Registers Low	02
Byte Count	04
Data, High Reg, High Byte	42
Data, High Reg, Low Byte	70
Data, Low Reg, High Byte	00
Data, Low Reg, Low Byte	00
Error Check Low	67
Error Check High	D5

Note: Data must be written in register pairs i.e. the “Starting Address” and the “Number of Points” must be even numbers to write a floating point variable. If the “Starting Address” or the “Number of points” is odd then the query will fall in the middle of a floating point variable the product will return an error message. In general only one floating point value can be written per query

The following response indicates that the write has been successful. But see also “Exception Response” later.

Field Name	Example (Hex)
Slave Address	01
Function	10
Starting Address High	00
Starting Address Low	02
Number of Registers High	00
Number of Registers Low	02
Error Check Low	E0
Error Check High	08

3.10 Exception Response

If the slave in the “Write Holding Register” example above, did not support that function then it would have replied with an Exception Response as shown below. The exception function code is the original function code from the query with the MSB set i.e. it has had 80 hex logically ORed with it. The exception code indicates the reason for the exception. The slave will not respond at all if there is an error with the parity or CRC of the query. However, if the slave can not process the query then it will respond with an exception. In this case a code 01, the requested function is not support by this slave.

Field Name	Example (Hex)
Slave Address	01

Function	10 OR 80 = 90
Exception Code	01
Error Check Low	8D
Error Check High	C0

3.11 Exception Codes

3.11.1 Table of Exception Codes

Eastron Digital meters support the following function codes:

Exception Code	MODBUS Protocol name	Description
01	Illegal Function	The function code is not supported by the product
02	Illegal Data Address	Attempt to access an invalid address or an attempt to read or write part of a floating point value
03	Illegal Data Value	Attempt to set a floating point variable to an invalid value
05	Slave Device Failure	An error occurred when the instrument attempted to store an update to its configuration

3.12 Diagnostics

MODBUS Protocol code 08 provides a number of diagnostic sub-functions. Only the "Return Query Data" sub-function (sub-function 0) is supported on Eastron Digital meters.

Example

The following query will send a diagnostic "return query data" query with the data elements set to Hex(AA) and Hex(55) and will expect these to be returned in the response:

Field Name	Example (Hex)
Slave Address	01
Function	08
Sub-Function High	00
Sub-Function Low	00
Data Byte 1	AA
Data Byte 2	55
Error Check Low	5E
Error Check High	94

Note: Exactly one register of data (two bytes) must be sent with this function.

The following response indicates the correct reply to the query, i.e. the same bytes as the query.

Field Name	Example (Hex)
Slave Address	01
Function	08

Sub-Function High	00
Sub-Function Low	00
Data Byte 1	AA
Data Byte 2	55
Error Check Low	5E
Error Check High	94